

Theodore E. Rose
Editor

J. F. Thompson
Associate Editor

J. B. Straughn
Technical Editor

L. L. Menne
Editor Emeritus

NRI NEWS

Vol. 19, No. 7

February-March, 1961

Published every other month by the National Radio Institute, 3939 Wisconsin Ave., N. W., Washington 16, D. C. Subscription \$1.00 a year. Printed in U.S.A. Second class postage paid at Washington, D. C.

EDITORIAL: IT'S "IN THE WORKS"

There is a story which was considered quite amusing 75 years ago! It has lost most of its humor with the passing of time, but the main point still makes good sense to me.

It's about a farmer who bought the first clock for his home. One day the hands failed to move around the face even though the farmer had wound it just as he always did. Puzzled, he removed the hands and took them to a town clockmaker. The clockmaker listened to the farmer's story; looked at the clock's hands. He said to the foolish man, "Go home and get the clock. The trouble is in the works, not in the hands."

Yes, it's "in the works" that the real job is done. When we see the hands of a clock move smoothly and efficiently, we know the works are doing their job well.

Many people who visit NRI at our Wisconsin Avenue home ask how it's possible to conduct the training of thousands of men in such a smooth, efficient operation. Visitors are naturally intrigued by the fact NRI receives over 12,000 letters every month plus numerous other pieces of mail.

Every letter must be opened, read, sorted, routed to the proper department, reread, and answered. Thousands of these letters require personally dictated and typed replies.

The NRI Lesson Grading Department receives about 7000 lessons a month. There are no machines in this section to check off right and wrong answers to lesson questions. Each lesson is hand-graded by a competent, experienced member of the NRI staff.

Our Kit Packing and Out-Mail Sections pack and ship an average of 4500 training kits to students every 20 working days. Some single kits contain over 300 parts.

I could quote dozens of other figures to show the scope of NRI's activities. But in a sense these statistics are meaningless. It has long been our objective to treat each student and

graduate as an individual with different problems, ideas, and needs. This ideal has been extremely rewarding, as evidenced by the growth and reputation of NRI.

I'm proud of NRI's smooth operation and the courteous, efficient manner in which we are able to serve NRI men. The ability to keep the "works" running as they should, has come about through 47 years of experience.

It should be a source of pride and reassurance to you as a student or graduate knowing that every man and woman here at NRI is dedicated toward providing YOU with the best possible training we can. The rest -- ? It's up to you.

J. E. Smith
Founder

Index

| <u>Article</u> | <u>Page</u> |
|--|-------------|
| Hi-Fi Corner | 2 |
| The New NRI Transistor Portable | 4 |
| How to Trouble-Shoot Horiz. Deflection Circuits | 11 |
| Your Consultation Service Privilege | 20 |
| Dressing Up the Model W VTVM | 23 |
| Alumni News | 27 |

Because a fellow has failed once or twice, or a dozen times, you don't want to set him down as a failure until he is dead or loses his courage -- and that's the same thing.

George H. Lorimer

Hi-Fi Corner

by John G. Dodgson

Product Report:

PILOT 240 STEREO AMPLIFIER



Quick Look: A very versatile high-quality unit that meets most of its important specifications and exceeds some of them. One unusual and worthwhile feature of the Pilot 240, termed "Stereo-Plus, Curtain of Sound" by Pilot, is provision for an (A + B) center-channel speaker without the need of another power amplifier.

In General: In addition to the usual complement of inputs, outputs, and controls, the Pilot 240 offers some features not found in most stereo amplifiers.

There are two pairs of low-level inputs, both RIAA equalized, marked "Phono RC" and "Phono TT." The "RC" and "TT" apparently stand for "record changer" and "turntable," respectively. This is a welcome feature in many installations since an inexpensive changer can be added to the system for the children.

A tape deck can be used with the 240 by plugging the heads into either of these phono inputs and adjusting the bass and treble controls to the points marked on the front panel to provide NAB tape equalization.

Personally, I don't like this system since accurate equalization is not possible because of the normal wide tolerance of the controls. In practice, fairly satisfactory results can be obtained from the tape deck by simply adjusting the tone controls for best sound, but it certainly would be better to have a separate properly equalized tape input.

Although there are separate bass and treble controls for each channel, the Pilot 240 is equipped with the "Pilot Tro Lok" tone control knob system. As the name implies, the "Tro Lok" system locks both bass controls and both treble controls together so that both bass controls are operated by one knob and both treble controls by another. If it is desirable, because of different speakers or unbalanced room acoustics, to adjust the tone

controls separately in each channel, this can be easily done by disabling the locking system. The controls can then be locked in a new position. The "Tro Lok," although appearing somewhat "gimmicky," proved to be a worthwhile feature in actual use.

As previously pointed out, the Pilot 240 features three output channels, the regular right and left channel outputs, and a combined output of both channels. This "Stereo-Plus" feature fills the "hole in the middle" when it is necessary or desirable to widely separate the right and left channel speakers. A simple system is provided to adjust the level of the center channel speaker.

In addition to the usual on-off switch, the 240 provides plugs on the chassis and a front-panel switch to permit the record changer to turn the 240 on and off. Since I don't use a changer, I can't comment on this, but I suppose it could be convenient.

Tests: These were carried out in our laboratories, as usual, with Hewlett-Packard and Tectronics equipment.

Sensitivity - Hum and Noise: Pilot rates the low-level input sensitivity at 3 millivolts; I measured 5 mv. High-level input sensitivity is rated at 110 mv; I measured 120 mv. With the system set up and the volume control adjusted for a very loud listening level at 5 mv input, hum and noise were inaudible from a normal listening position. At this and louder levels, with no signal input, listening right at the speaker showed the tube noise to be higher than the hum level.

Power Output: Continuous power output of the Pilot 240 is supposed to be 12 watts per channel - I measured 16 watts, which is even more than Pilot's 15-watt IHFM music power rating.

Frequency Response: The graphs in Fig. 1 clearly show the response at the 1-watt and

(A) ODB = 1 WATT

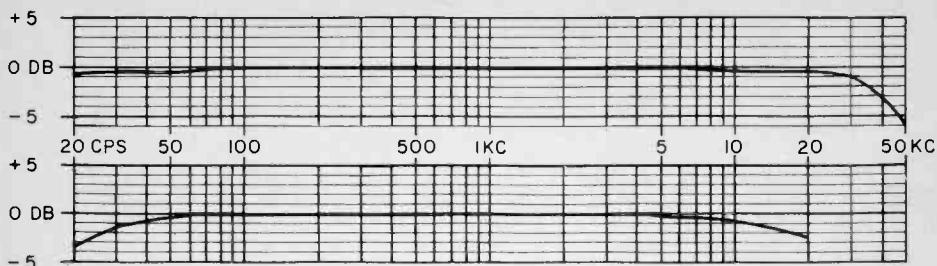

(B) ODB = 15 WATTS

FIG. 1. Frequency response of the Pilot 240. Chart (a) shows the response at 1 watt output per channel; (b) shows the response at 15 watts per channel.

15-watt levels. No one can complain about the listening-level response - it is excellent. The rounding off at the very low and very high frequencies at maximum output is normal for this type of amplifier. Square-wave tests were very satisfactory, showing good transient response.

Tone Controls: Measured response of the tone-control action was both good and bad. Bass and treble cut were both more than are ever needed; I measured -26 db cut at 20 cps, and -23 db cut at 20 kc. Bass boost was quite satisfactory -- at half-boost, response at 20 cps was increased +7 db with only a +1.2 db boost at 100 cps. Treble boost was disappointing. A maximum of 6 db was measured (which is enough) but the upper highs could not be boosted without affecting mid-range.

Equalization: RIAA equalization was checked and found to be way above average in accuracy. The average error was only .41 db, and this did not increase below 100 cps and above 10 kc. It is not unusual to find a 3-db error at these frequencies in most amplifiers of this and higher priced classes.

Loudness: According to Pilot, the loudness switch is supposed to increase bass response at low levels; however, measurements showed insignificant bass boost. Further measurements were discontinued in favor of listening tests which have proved in the past to be a better evaluation of this feature.

Listening Tests: I had no trouble in setting up or using the Pilot 240 in a complete stereo system.

The loudness switch was judged to be almost useless. When "on," it does provide a slightly audible bass boost, but it is far better and easier to simply advance the bass control.

The lack of treble boost (see above) did not

prove to be the slightest hindrance - perhaps because of the very accurate equalization. In fact, with horn tweeters the sound was a little too bright for my ears and better balance was obtained by slightly reducing the treble control.

Over-all, the sound was clean and smooth. Despite the bass drop-off on the power curve, loud-level bass passages were full and clear. This, again, may have been due to the accurate bass-boost equalization.

To take advantage of the Pilot "Stereo-Plus" feature, the 240 was connected in a 3-channel setup with the right and left channel speakers 15 feet apart.

The resulting wide-stage stereo was superb and it didn't require another power amplifier to do it.

KNOWLEDGE

It has been said that most of us achieve only a portion of our potential. We possess capabilities which need only to be developed. That extra degree of effort must be expended if we are to broaden our horizons. Each of us lives within his own intellectual environment. Or, to put it another way, each of us possesses a span of knowledge, narrower or wider, as the case may be. Regardless of how wide the span of knowledge, there is always an area totally unknown to us. The desire to penetrate that dark space will lead us toward broader horizons if we will supplement our desire with the positive ingredient called ACTION.

Agnes E. Carlson
"Broader Horizons."



J. B. Straughn

The Model 291 transistor portable features a brand-new design. It is modern in every respect and will outperform other makes that cost much more.

Made in USA

No Japanese parts are used in this receiver. All parts, with the exception of the various transformers, are readily available from any parts distributor. The transformers are made to our specifications by large U. S. manufacturers. RCA PNP transistors are used throughout, and the germanium diode is also an American product.

High Sensitivity

Stations hundreds of miles away come in at night like locals if conditions are favorable. Locations that are unfavorable are in cars, in completely shielded buildings, and under noisy high-tension wires. This receiver, however, has picked up New York, Connecticut, Pennsylvania, and Virginia stations while lying between the sand dunes on the Delaware and Maryland ocean beaches. It does this in the daytime. At night near NRI it has picked up strong stations from Canada to New Orleans, so that they sounded like locals.

In a car equipped for ignition-noise suppression, pretty good local and semi-distant reception can be obtained with the set placed on the car dash, against the windshield; otherwise it should be operated on the front or back seat. However, the 291 does not completely replace a car radio. The 291 uses a directional high-Q loopstick for an antenna, and a sudden turn in the road may "lose" the

The New NRI Transistor Portable

By
J. B. Straughn

Chief, Consultation Service

signal. Of course you could turn the set, but this is dangerous while driving. Also, if noisy power lines parallel the road, the noise will override the signals. Ordinary road noise can drown out weak programs. The Model 291 will put out enough sound to be uncomfortably loud in a quiet room, but its 100 undistorted milliwatts of audio power just can't compete with the 5 to 10 watts available from most auto radios.

Tone Quality

After listening to pocket-sized transistor portables, the average person classifies them as toys. They sound tinny, and quickly distort when the volume is advanced. This is mainly due to the small, cheap speakers used and to the design of the audio system.

The tone of the Model 291 is an eye opener. Even Jack Dodgson, NRI's hi-fi fiend says it's the best, and I have not heard an AM set (tube or transistor) that sounds better.

This is partly because of the premium loud-speaker. It has only a four-inch diameter cone, but uses a 1.5-oz magnet. The high-quality transformers help, too, as does the class B output stage. The final clincher for the excellent tone is the degenerative output circuit. The wave shape of the output signal looks just like the input signal when viewed on a scope.

Low Current Drain

The Model 291 receiver is designed to operate from a 6-volt source produced by four 1.5-volt pen-lite cells in series. The idling

current with no signal is about 8 ma. When the volume control is advanced, the class B output transistors begin drawing more current. Normal room volume results in a current drain of 15 ma on signal peaks. Between the audio peaks, the current drops back to the idling value. At ear-splitting volume, before overloading occurs, the peak drain may reach 40 ma. The receiver works well when the voltage drops as low as 4.4 volts. If it is played loudly for 2 hours each day at an average current drain of 20 ma, the battery life down to 4.4 volts is 64 hours. This means 32 days pass before you think about battery replacement. At room volume (10 ma average drain), this stretches out to 135 hours, or 65 days. These figures are for the premium cells supplied by NRI as original equipment. Such cells are available everywhere, or you can use less expensive pen lites.

The heavy duty equivalent is the Eveready size AA No. 1015 cell. The shorter-lived Eveready size AA No. 915 can also be used. The 1015 or the equivalent RCA VS334 retails for 25¢ or can be purchased from your favorite radio wholesaler for about 17¢ each. It takes about two minutes to change cells.

The low current drain of the Model 291 is due to the circuit design of the class B output stage. Other sets, operating from a 9-volt battery and using a single-ended output

stage, will draw a steady 18 to 20 ma regardless of the volume-control setting, and will need battery replacement more often. This is particularly true of Japanese batteries which have seen considerable shelf life before being used.

The Model 291 Circuit

The schematic of the 291 is shown in Fig. 1. Six transistors and a 1N60 germanium diode are used to provide the high sensitivity, low current drain, and exceptional tone quality.

The set uses a 2N411 as a mixer oscillator, two 2N409's as the first and second i-f amplifiers, the 1N60 as the second detector-avc, a 2N407 in the first af driver stage, and two 2N407's in the class B output stage.

Let's take a look at the circuitry and see how the signals travel through the receiver.

How The Model 291 Works

When a station is tuned in, the waves from the station will induce a voltage in the primary of loopstick L_1 . The primary is tuned to resonance by the rf section of the tuning-capacitor gang. The high resonant current sets up a magnetic field through the core of the loopstick and induces a voltage in the secondary of L_1 . This voltage is applied to



the base of Q_1 through capacitor C_1 , and to the emitter by way of the tapped section of L_2 and C_2 .

Variations in collector current flow through the primary of L_2 and induce a voltage in the tuned secondary. This is the oscillator tank circuit. The tank is shock-excited into oscillation at its resonant frequency by the induced voltage pulse. A portion of the oscillator tank voltage is fed to the emitter through C_2 and to the base through the secondary of L_1 and C_1 . The resulting variations in the base-emitter forward bias of Q_1 vary the collector current, so oscillation is sustained.

The incoming signal and the oscillator signal are both varying the emitter-base forward bias. The bias is such that Q_1 acts as a detector. This causes mixing to take place. In the collector circuit we have the oscillator signal, the incoming station signal, and the sum and difference frequency of these two signals. Because the oscillator frequency is 455 kc above the station frequency, the difference frequency is 455 kc. This is the i-f signal and contains the original modulation envelope of the station signal. This signal in flowing from terminal 3 to terminal 5 of the primary of T_1 induces a voltage in section 5-4. The primary is tuned to 455 kc, so a large current circulates in the primary at this frequency. The two original signals and this sum also flow from 3 to 5 and induce a voltage between 5 and 4. These signals are very small because they are so far from the resonant frequency and do not induce a noticeable voltage in the secondary of T_1 .

The i-f signal induces considerable voltage in the secondary. This voltage is applied to the base of Q_2 , and through C_4 , to the emitter. Transistor Q_2 amplifies this i-f signal and it appears across the primary of T_2 , inducing a signal in its secondary. This amplified i-f signal is applied to the base of Q_3 , and

through C_5 to the emitter of Q_3 . Again amplification of the i-f signal takes place and it is coupled by T_3 to the 1N60 diode detector. When terminal 1 of T_3 is positive, electrons flow from terminal 2 to the chassis at point 7, through the volume control and the 1N60 diode, and to terminal 1. When the i-f signal polarity reverses, the 1N60 does not conduct, and no current flows. Because of this rectification, the audio modulation appears across volume control R_{10} , which is the diode load. Bypass C_9 removes the i-f signal, leaving only the audio modulation.

Because of the direction of the electron flow, the upper terminal of the volume control is positive, and becomes more so as the i-f signal strength increases. (More on this later when we discuss the avc system.)

By adjusting the volume control, any desired amount of the audio signal present may be applied to the base of Q_4 through coupling capacitor C_{10} and to the emitter through the chassis and emitter bypass C_{11} . Q_4 amplifies the audio signal, and the collector current of Q_4 flows through the primary of transformer T_4 .

T_4 is a regular input push-pull transformer with the correct turns ratio to match Q_4 to Q_5 and Q_6 . The secondary inverts the signal because of its center tap, so the signals applied to Q_5 and Q_6 are 180° out of phase. The signals are applied to the bases of Q_5 and Q_6 , and through R_{14} to the emitters.

Q_5 and Q_6 act as class B push-pull power amplifiers. The signal currents flowing through the primary of T_5 result in cancellation of even-harmonic distortion, and the fundamental of the signals induces a voltage in the secondary. The signal current flows through the voice coil and results in cone movement and audible signals.

Operating Voltages

The dc operating voltages are shown on the schematic, next to the transistor element leads. These were taken on the -DC range of the Model W VTVM. The 12-volt range was used for collector measurements, and the 3-volt range for the base and emitter measurements. The oscillator ac tank voltage was measured on the 3-volt ac range. All measurements were made to the receiver chassis.

The base voltages are obtained by means of voltage dividers and are fairly constant, since not much base current is drawn. The emitter voltages are due to emitter current flowing through the resistance between the emitters and the chassis. The emitter voltage of both

TWELVE THINGS TO REMEMBER

1. The value of time.
2. The success of perseverance.
3. The pleasure of working.
4. The dignity of simplicity.
5. The worth of character.
6. The power of kindness.
7. The influence of example.
8. The obligation of duty.
9. The wisdom of economy.
10. The virtue of patience.
11. The improvement of talent.
12. The joy of originating.

Marshall Field

Q₅ and Q₆ is zero, since the emitters are grounded.

The base voltage of Q₁ is produced by the divider made up of R₁ as one branch, and R₂ as the other branch. The base voltage of Q₂ is produced by the divider made up of R₄ as one branch, and R₅ and R₁₀ as the other branch. The base also draws a slight current through R₄, increasing the voltage drop across it. As we stated before, a rectified dc voltage exists across R₁₀, and the ungrounded end of R₁₀ becomes increasingly positive with increases in signal strength. This bucks the voltage across R₁₀ due to voltage division. As the signal strength increases, the base is brought nearer the emitter potential, with a resulting decrease in emitter-base forward bias. This reduces the stage gain. If the signal strength becomes less, the base becomes more negative, and the stage gain increases. In other words, we have AVC action. C₃ and R₅ act as a filter to keep the audio signals at the volume control from reaching the base of Q₂.

The base of Q₃ is biased by R₇ and R₈, and the base of Q₄ by R₁₁ and R₁₂. Notice the 100-mfd bypass, C₁₁, across R₁₃. This bypass prevents the degeneration that would otherwise occur.

To set the base voltage of Q₅, we make use of the divider formed by half the primary of T₅ plus R₁₅, and half the secondary of T₄ plus R₁₄. In the same way, the other half of the primary of T₅ plus R₁₆, and the other half of the secondary of T₄ plus R₁₄ bias the base of Q₆.

Notice that we are not only feeding some dc through this divider, but also a portion of the output signal. This signal feedback is degenerative, so any distortion present at the output of T₄ is cancelled out. This accounts for the remarkable tone quality.

An i-f amplifier using a PNP transistor has in-phase feedback from the collector to the base. If the gain is high, this results in oscillation. To avoid this effect, an equal quantity of signal 180° out of phase is also fed back. The two feedback signals cancel out, and oscillation is thus avoided. An out-of-phase signal exists at terminals 4 and 1 of T₂ and T₃. We have chosen to use the signals at points 1 of the transformers. Capacitor C₇ between 1 of T₂ and the base of Q₂ feeds back out-of-phase signal, as does C₈ between 1 of T₃ and the base of Q₃. These are known as "neutralizing" capacitors, and unlike those used in early radio receivers have a predetermined fixed value. The difference in the size of C₇ and C₈ is due to the electrical differences in T₂ and T₃.

Feeding back from point 4 to the base would call for smaller neutralizing capacitors, and their value would be more critical. Using the number 4 terminals would require approximately 5 mmf for C₈ and 7 mmf for C₇.

Determining the value of C₈ and C₇ was simple but interesting. A variable trimmer was substituted for C₈, and a 455-kc signal from a signal generator was fed to terminal 1 of T₃. The resulting feedback was observed at the base of Q₃ with a cathode-ray oscilloscope. The capacity of the trimmer was varied until the oscilloscope indicated minimum signal. The trimmer was then removed and its capacity measured on the NRI Model 311 R/C Bridge. A fixed capacitor of the same size was then used as C₈. The correct capacity for C₇ was determined in a similar way.

Using The 291 in the NRI Practical Training Plan

With the NRI Practical Training Plan you gain servicing experience by introducing typical defects in the receiver circuits. Then you practice localizing the defective section and stage. You take voltage and, where applicable, resistance measurements to locate the "defective" part or circuit. You carefully note the effect on reception. Then, when you meet the same symptom in actual service work you will know how to localize the defective stage, how to check for the defective part, and the type of defect you will be likely to encounter. There is no substitute for experience of this sort.

A great many Model 291 receivers are purchased for use in carrying out this plan. Later the receivers serve their normal purpose. The plan will be easier to follow if you make temporary connections in assembling the set. Such joints can be easily unsoldered, but the set will be a little harder to wire. If you make temporary joints, solder each time a wire or connection is put in place and do not make tightly crimped connections. The following are some of the defects and experiments you may introduce:

Dead Oscillator. Note the effect on reception and oscillator ac tank voltage with C₂ disconnected at one lead to give the effect of an open. Repeat with C₁ opened. Repeat with the secondary of L₁ opened (unsolder one lead of the wire between terminal 1 to terminal 13). Note the effect of varying the value of R₃ and increasing R₁.

I-F Instability. Cause i-f amplifier to oscil-

Some wives insist a fishing pole
is a stick with a worm at each end.

late by reducing value of R_4 (shunt with another resistor). Disconnect one lead of C_7 , and repeak slug of T_2 to show effect of incorrect neutralization. Short R_6 to increase bias.

Loss of I-F Gain. Open C_4 ; use smaller capacitor in place of C_4 (.001-mfd or less). Shunt R_5 with a smaller resistor to reduce forward bias on Q_2 . Open C_5 and then C_6 .

AF Troubles. Show leakage in C_{10} by shunting with 10K-ohm resistor. Show short in C_{10} . Try reversing connections to 1N60 and note effect on audio and on avc action. Open C_{11} . Increase value of R_{11} . Disconnect R_{15} and R_{16} at T_4 secondary; next connect these resistor leads to terminal 3 on T_4 and then to chassis. Short R_{14} . Short R_{17} , and note effect with volume turned on full. Reverse one pen-lite cell, and note effect on signal. Open C_{12} by disconnecting one of its leads.

Other possible defects will occur to you. There should not be any permanent damage to any transistors unless the defect causes a substantial increase in forward bias over some period of time. After each defect is introduced and you have made your tests, be sure to restore the circuit, checking to see that operation is normal again. Then you can go on to the next defect.

You can interchange transistors if you wish without damage. In some cases you will find that the af transistors will work at i-f frequencies. Usually a high-frequency transistor will work in a lower frequency position.

Learn how to localize a dead stage with the

ohmmeter in the Model W VTVM. Open an emitter circuit to produce a dead stage. Set the Model W up as an ohmmeter. Attach the clip to the chassis, set the range switch to RX1K and touch the probe to the base of each transistor in turn, working from the output towards the antenna. When you touch the base of one of the transistors, you will hear a click in the loudspeaker, and when you go from a click position to a no-click position you have just passed through the defective stage. The ohmmeter voltage of the Model W is too low to damage the transistors, and the Model W meter is too rugged to be damaged by these tests.

You can simulate transistor defects easily. Low-power transistors such as these are subject to two major defects - open base connections and collector-to-emitter leakage. To give the effect of an open base, unsolder the connection at the base socket terminal. A 100K or smaller resistor between collector and emitter will cause the transistor to act as if the collector-to-emitter leakage were excessive.

How to estimate Parcel Post charges from D. C.

| | |
|-----------------------------------|-----|
| Local | 26¢ |
| Zone 1 & 2, up to 150 miles | 38¢ |
| Zone 3, 150 to 300 miles | 41¢ |
| Zone 4, 300 to 600 miles | 47¢ |
| Zone 5, 600 to 1000 miles | 55¢ |
| Zone 6, 1000 to 1400 miles | 64¢ |
| Zone 7, 1400 to 1800 miles | 74¢ |
| Zone 8, over 1800 miles | 83¢ |

ORDER BLANK

NATIONAL RADIO INSTITUTE 3939 Wisconsin Ave., Washington 16, D. C.

291 KT

I enclose \$..... plus \$..... postage. Send items checked below.

..... Portable Transistor Receiver Kits, each \$22.50 cash OR \$12.00 herewith and two \$5.75 monthly payments.

Parcel Post

5% discount on cash orders of 3 or more receivers

Total

Name

Address

City Zone State

(If you live in Washington, D. C., add 2% Sales Tax)

Mystery Student!

Who is He?

Some time ago we received the following letter:

"Dear Mr. Straughn: Received your most welcome letters and was more than glad to hear from you. I am sorry that I didn't answer sooner but have been quite busy. I am going to have to ask you to be patient with me for a little while more. I thought I would be able to do some of the work while I am working but was unable to. I hope you don't think that I have forgotten about my course. I haven't. I will start when I get through my work. I'm not one to give up on something that I start and like to give most of my time to it. I am going to try very hard to pass this course as I know how much it will help me later. Please believe me when I say I have learned a lot from what I have studied. I hope to hear from you soon. As ever your student."

Nice letter? Surely. And Mr. Straughn, our cooperative Chief of Consultation Service, would have liked very much to send a speedy answer. But where, and to whom? The envel-

ope had no return address, there was no address or student number on the letter itself, and it wasn't even signed. Our only clue was the postmark "Herkimer, New York" which just wasn't enough to enable us to identify this fellow.

Our student probably waited patiently for his reply and when he didn't get it, must have thought that Mr. Straughn was falling down on his job.

So a friendly word of advice to all NRI men: when you write, be sure to include your full name, complete address, and student number on both the envelope and your letter. If you are a graduate, write "Grad." after your name. That way you'll get quick answers to the letters you send NRI.

HEAVENLY CREATURE

No wonder I frequently call my wife an angel: she's always up in the air about something, always harping on something, and never has an earthly thing to wear.

Times-Record, Spencer, W. Va.

**A favorite with Radio-TV men
everywhere—**



ARGOS Tube Caddies

The easy, orderly way to store tubes or carry tubes and tools on service calls. Perfect for spare-time servicing. Argos Caddies make work easier and quicker—make you more efficient. Divided sections give tube inventory at a glance. Missing cartons are easily spotted.

Argos Caddies are covered with good-looking, tough, luggage-type pyroxilin—resistant to wear and soiling. Constructed

of durable $\frac{5}{8}$ " and $\frac{1}{4}$ " plywood. Built for years of service.

The NRI Supply Division offers you a choice of two caddies. Carry-All Caddy is 21" x 15" x 8"—holds 262 tubes. Your price including postage—just \$13.95.

The Junior Tube Caddy holds 143 tubes. Size: 15 $\frac{1}{4}$ " x 12 $\frac{1}{2}$ " x 8". Price including postage—\$9.95.

Order from:

NATIONAL RADIO INSTITUTE

SUPPLY DIVISION

WASHINGTON, D. C.

How to Trouble-Shoot Horizontal Deflection Circuits

By Joseph Schek
NRI Consultant



Joseph Schek

Service technicians do not need a crystal ball to realize that a high percentage of TV circuit troubles involve breakdowns in horizontal sweep and high-voltage systems. This article will help develop your ability to analyze typical horizontal-sweep and high-voltage circuits and to correct their operating troubles.

The block diagram in Fig. 1 shows the position of each stage and the normal wave shapes in a complete horizontal sweep system.

HORIZONTAL SWEEP OSCILLATORS

Synchroguide Circuits. The synchroguide horizontal oscillator-control circuit shown in Fig. 2 is widely used. You should understand it thoroughly.

This oscillator is easily recognized by the two adjustable coils - L1 and L2. Coil L1 determines the oscillator frequency, and L2 produces the stabilizing sine-wave form. Ordinarily the coils are wound on the same form, each on one end, and installed in a can. The adjusting slugs for the two coils extend from opposite ends of the can. Usually you will see the frequency-adjust slug at the back of the chassis where it is easily accessible. The other slug, for the waveform-adjustment,

is usually under the chassis.

These coils are not always shielded, and you may find two separate coil assemblies, mounted either on top of the chassis or on its rear wall so both slugs can be reached without pulling the chassis. Adjustment of the stabilizing sine-wave slug is usually indicated if you see what appears to be violent and erratic jittering, particularly through the center of the picture. Figs. 3 and 4 illustrate this typical horizontal synchroguide oscillator trouble. It is frequently referred to as the "Christmas Tree" effect.

Although the waveform adjustment will determine stability, the frequency is controlled by the inductance of L1 and the time-constant of C1 and R1-R2.

A defect in mica-capacitor C1 or in the .01-mfd capacitor across L2 will cause loss of output. These are common troubles. When you suspect these capacitors, replacing them is the best test.

The frequency of the horizontal oscillator is regulated by the dc charge placed on C3 by the oscillator control tube. Resistors R2 and R3 (Fig. 2) act as a voltage divider across this capacitor, and supply the proper dc voltage level through resistor R1 to the grid of

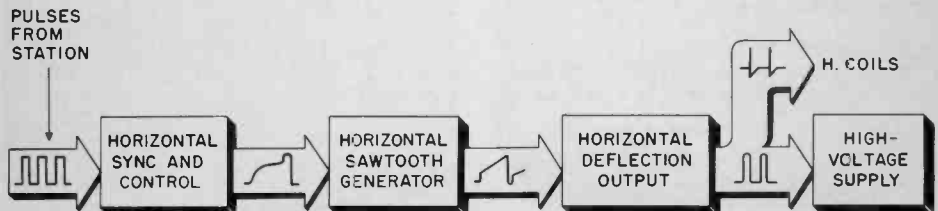

FIG. 1. Block diagram of horizontal sweep system.

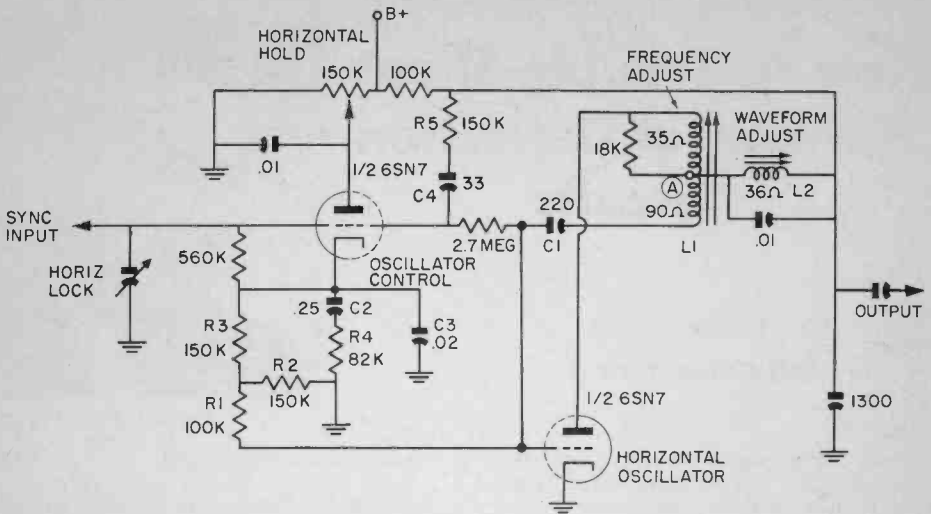

FIG. 2. Synchroguide horizontal sweep oscillator and control tube.

the horizontal oscillator tube.

The adjustment of the horizontal-hold control varies the plate current of the oscillator control tube and therefore the dc charge on C3. This charge is also affected by the shape of the pulse applied to the grid of the control tube from the output by way of R5 and C4. The duration of this pulse is determined by the frequency relationship between it and the station horizontal sync signal.

In your service work you are certain to encounter particularly stubborn cases of intermittent loss of horizontal sync. These symptoms, shown in Fig. 5, are a reminder to try replacing those capacitors - both high and low values - in the plate, cathode, and control grid circuits of the oscillator control tube.

Multivibrator-Type Horizontal Oscillator.

Fig. 6 shows a cathode-coupled multivibrator (V14) type of horizontal sweep generator, with its afc circuit. The operating frequency of V14 is determined by the time constant of C37 and R56-R57. The multivibrator oscillator on a set can quickly be identified by its ringing coil and adjustment slug.

You adjust this coil slug to provide maximum horizontal sync stability of the picture. At this setting, the ringing coil and C36 are parallel-resonant at the oscillator frequency. The purpose of this circuit is to shape the waveform that develops at the plate of the first section of the tube to provide more positive locking between the oscillator and incoming sync pulses.

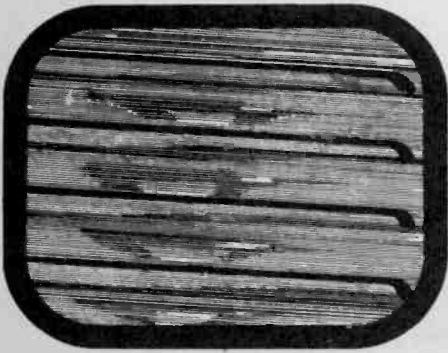

FIG. 3. "Christmas tree" effect.

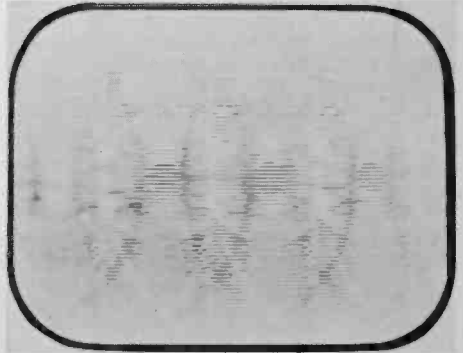

FIG. 4. Horizontal oscillator operating at the wrong frequency.

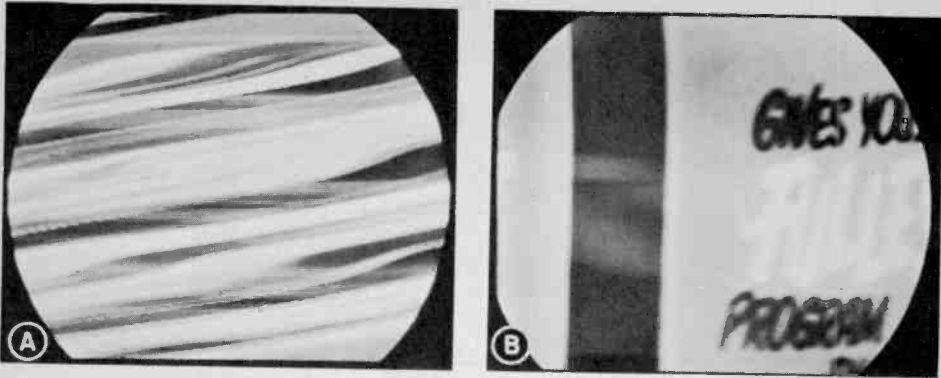

FIG. 5. Loss of horizontal sync.

The comparison pulse signal for the afc can be taken either from point 97 as shown, or from a winding or tap on the flyback transformer. This signal is fed through the 8.2K-ohm resistor to pins 5 and 7 of the 6AL5 phase detector.

When confronted with hard-to-locate causes of poor horizontal sync or oscillator operation, remember to very carefully test all components associated with the comparison-signal feedback network.

Other Causes for Poor Horizontal Sync. In recent sets, a pair of small selenium diodes may be used instead of the 6AL5 tube shown in Fig. 6. You can see that this is less expensive to manufacture and does eliminate troubles due to cathode-to-heater leakage. But experience with these selenium diodes shows a surprisingly high rate of sync troubles caused by their breakdown.

Because these dual-diodes are not easily located or quickly checked by substitution as a tube is, much time can be wasted if they are overlooked as a trouble source in horizontal sync and sweep circuits.

In trouble-shooting horizontal oscillator circuits, use your ohmmeter to verify resistor values. Compare your readings with the indicated color codes or diagram information. The confident and successful service technician when "on the prowl" to locate the cause of a circuit fault, never leaves even a single capacitor, resistor, or control untested (frequently by substitution) in the stage or section known to be the trouble-maker.

Again and again experience proves that hard-to-find troubles in horizontal sync and related circuits can be licked by systematically going over each part.

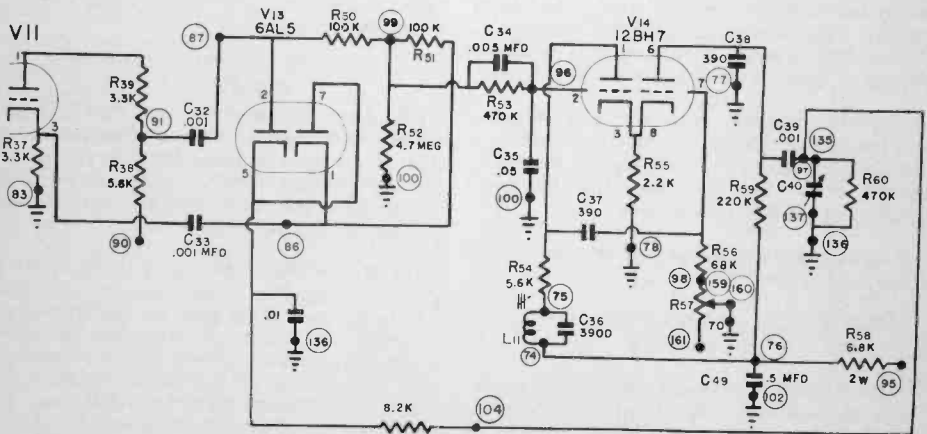

FIG. 6. Schematic diagram of horizontal phase detector (V13) with horizontal oscillator (V14) and horizontal sync phase splitter (V11).

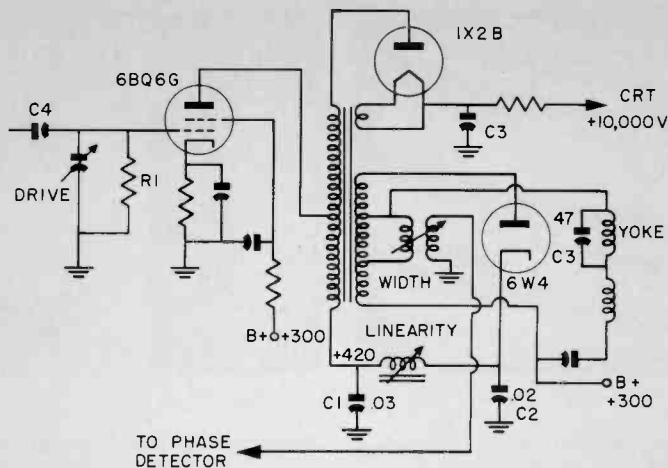

FIG. 7. Horizontal amplifier showing damping circuit and high-voltage rectifier.

For example, an RCA chassis with an uncorrected complaint of insufficient oscillator output (leading to low drive and overheating of the horizontal amplifier tube) was brought to the writer. The assurance was made that "all" parts had been checked, but none were found to be faulty. This set used the typical synchroguide shown in Fig. 2.

Initial testing showed some output signal present only when there was no load at the output. With the output stage connected, the oscillator signal dropped almost to zero.

By systematically testing each capacitor in the oscillator circuit with an NRI Model 114 capacitor tester, the faulty capacitor was localized. It was the 1300-mmf capacitor connected between the oscillator output and ground. The leakage in the capacitor which caused this trouble developed only when a voltage of several hundred volts was applied.

A capacitor checker with high test voltage was required to pinpoint this faulty capacitor. The usual ohmmeter check had given the misleading indication that the capacitor had satisfactory leakage resistance.

Let us now investigate the operating features of horizontal amplifiers.

HORIZONTAL SWEEP AMPLIFIER CIRCUITS

The horizontal output stage and related damper, yoke, and high-voltage circuit probably operate under the most critical conditions in a TV set.

The horizontal output stage not only provides

the horizontal deflection power but also energy to heat the high-voltage rectifier filament, and the 12,000 to 18,000 volts for rectification and application to the picture tube anode. In addition, the B+ boost from the damper output may serve as the B supply source for some section of the receiver or even for the plate of the horizontal output tube itself.

In Fig. 7 you see one type of horizontal output system. The flyback transformer in this circuit uses separate primary and secondary windings. Another popular horizontal output arrangement is shown in Fig. 8. Here you see an auto transformer with the typical single-tapped winding. It is interesting to note here that these variations between horizontal output transformers are also found in vertical output transformers.

GENERAL TROUBLE-SHOOTING PROCEDURES

When your customer's complaint is a no-raster condition with normal sound, and your first check with an insulated screwdriver at the high-voltage rectifier plate shows little or no arc, you have already isolated the trouble to the flyback system.

After the arc test, determine if the negative grid drive and the screen-grid voltages for V1 are normal. If the grid voltage is low, re-measure with the output tube plate lead disconnected. A sharp increase in drive voltage with the plate cap off indicates trouble in the output tube, flyback transformer, damper, or yoke circuits. The yoke and transformer and tube V2 are the first items to check, once you have established that the trouble could be caused by a defect in the flyback system.

NOW! -- SAVE \$ \$ on the NRI Professional Model 12 VTVM with TV Probe

(for a limited time only)

Regular Price is:

| | |
|---------------------|---------|
| Model 12 VTVM | \$45.00 |
| TV Probe | 6.50 |
| | <hr/> |
| | \$51.50 |

Order NOW -- Get
Both for only
\$45.00

(Note: A comparable VTVM, with TV probe, sold under the manufacturer's own name would cost over \$80.00 at serviceman's prices. Through quantity purchases, NRI is able to pass an even greater savings on to our students and graduates.)



SPECIFICATIONS

1. DC Volts—Five ranges, 0-1200 volts, provide for all basic dc measurements in Radio and Television. With High Voltage TV Probe (available at extra charge), dc range is extended to 30,000 volts. Voltmeter polarity switch eliminates reversing leads. For correct polarity just change polarity switch.
2. AC Volts—Five ranges, 0-1200 volts, cover power frequencies, and supersonic frequencies.
3. Peak-to-Peak AC Volts measure up to 3200 volts in five ranges. Maximum shunt capacity of input cable 67 mmfd.
4. Ohmmeter Measurements—Up to 1000 megohms in five overlapping ranges. This permits measurements of extremely small and large resistances. Tests condensers for leakage and opens. Low ohms scale for checking coil windings. One zero adjustment serves all five ranges.
5. Zero Center Scale—Shifts electrical zero of the dc voltmeter from left end of scale

to center of scale in a jiffy. A very important type of measurement in balancing FM and TV discriminator circuits, or in making measurements of unknown polarity. Five ranges 0 to ± 600 volts.

Output Measurements in connection with alignment. High dc sensitivity makes the Model 12 ideal for avc output measurements. DC blocking condenser on ac ranges permits measuring audio signal at plate of output tube.

Twenty-Five Separate Ranges

| DC Volts | AC Volts | Ohms |
|----------|----------|-------------------------------------|
| 0-3 | 0-3 | 0-1000 (10 ohms center scale) |
| 0-12 | 0-12 | 100K (1,000 ohms center scale) |
| 0-60 | 0-60 | 0-1 Megs (10,000 ohms center scale) |
| 0-300 | 0-300 | 0-100 Megs (1 Meg center scale) |
| 0-1200 | 0-1200 | 0-1000 Megs (10 Megs center scale) |

PANEL: Brushed aluminum field, contrasting black deep-etched characters.

CASE: Metal, black ripple finish, with perspiration proof plastic handle, over-all size: 7¼" x 5½" x 3½".

METER: 400 microampere, double-jeweled D'Arsonval construction, ± 2%. Large 5½-inch meter—easy to read.

ACTUAL WEIGHT: 5¼ lbs. SHIPPING WEIGHT: 7 lbs. INCLUDES: Operating instructions and schematic diagram, AC-DC-Ohms probe, two 1½ volt flashlight cells.

TUBES: One 12AU7; two 6AL5 tubes.

POWER REQUIRED: Operates only on 50-60 cycles, 110-120 volts ac.

WARRANTY: Standard 90-day EIA warranty.

Compare the NRI Professional VTVM with other instruments of this type. For quality and price you will find yourself coming back to the NRI VTVM as your best buy. We sincerely believe this instrument is unsurpassed in quality at this low price.

Universal Test Probe Included

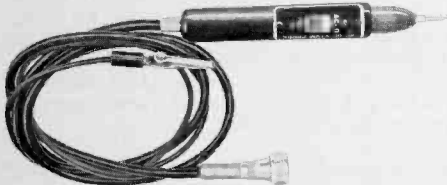

Universal test probe (above) included at no extra charge. Handy switch in handle. Throw in one direction for all AC volts, PEAK-TO-PEAK AC volts and Ohm measurements; in opposite direction for all DC volts measurements.

Optional Accessories

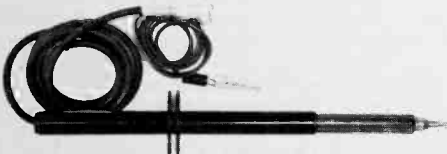

High Voltage TV Multiplier Probe

Illustrated above. Extends DC volts range to 30,000 volts for SAFE high-voltage TV measurements. Heavy-duty bakelite handle with two-inch high voltage barrier. Helical film-type cartridge multiplier resistor.

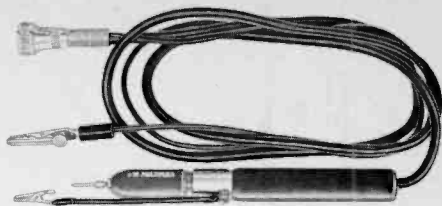

Optional Accessory
Crystal Detector High Frequency Probe

Illustrated above. Gives positive peak voltage values for sine-wave voltage up to a maximum peak value of 120 volts. Frequency range up to 250 mcs. Well-made probe, shielded lead and connector. Price \$9.50. This probe not included in special sale.

Sent express collect. Please use order blank below. (Personal checks should be certified to avoid 10 to 15 days' delay in shipment waiting for checks to clear.)

----- cut here -----

USE THIS BLANK TO ORDER YOUR VTVM

NATIONAL RADIO INSTITUTE ITE
3939 Wisconsin Ave., NW
Washington 16, D. C.

I enclose \$..... (certified check, money order or bank draft) for which send me, by Railway Express, charges collect, the items I have indicated in the box on the right.

One NRI Professional Vacuum Tube Voltmeter, Model 12, including Universal test leads, insulated alligator clip, detachable isolating probe for dc measurements and High-Voltage TV Multiplier Probe

| Price | Write price here and add this column |
|---------|--------------------------------------|
| \$45.00 | |
| \$9.50 | |
| | |

One Crystal Detector High Frequency Probe

(If you live in Washington, D. C., add 2% D. C. Sales Tax)

Total amount enclosed

Tell me how I can buy this instrument on monthly terms.

Name Student No.

Address

City State

Express Office

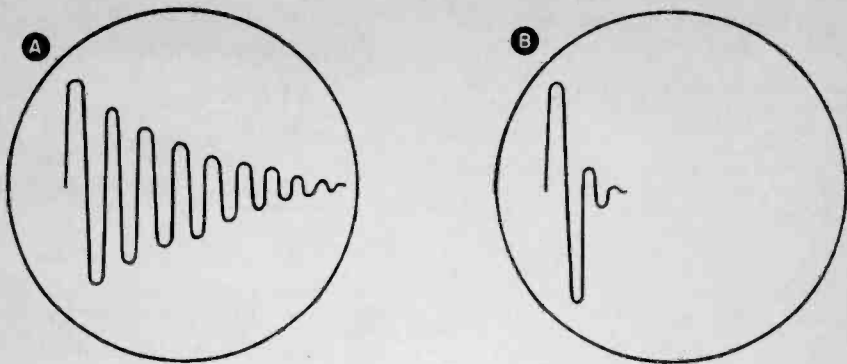

FIG. 9. Waveform produced by a good inductance in the horizontal sweep generator is shown at A; the waveform at B is produced if either the flyback or the yoke has an internal short.

Where the part is completely shorted, there will be no vertical deflection - only a horizontal line. As a guide in helping you to secure the most usable scope response in these tests by properly setting the horizontal sweep frequency, the following table has been prepared:

| Component | Sweep Rate |
|--|---------------|
| Width coil | 1-10 kc |
| Horizontal linearity coil | 1-10 kc |
| Horizontal output transformer | 100 cps-10 kc |
| Deflection yoke | 1-10 kc |
| Receiver deflection circuit with yoke connected | 1-10 kc |
| Receiver deflection circuit with yoke disconnected | 100 cps-10 kc |

Adjust the fine frequency to show as clearly as possible the individual cycles of the damped wave-train.

Testing the Complete Horizontal Deflection System. You can quickly test the complete horizontal deflection system of a TV receiver by removing the plate cap of the horizontal output tube and connecting the scope input probe tip (use direct probe if you own the probe set) to the cap lead of the transformer. Clip the ground lead of the probe to the receiver chassis, or, in AC-DC sets, to B-. Even one shorted turn in any of the horizontal sweep components will produce the short damped waveform in Fig. 9B.

You may simulate this result in a good flyback transformer by shorting the ends of the

high-voltage rectifier tube filament winding. You should see the waveform of 9A changing to the one shown in 9B.

When making these tests, the TV set must be off and the line cord disconnected from the wall outlet.

Modifying Other Scopes. Some scopes apply a blanking pulse to the crt cathode; others apply it to the control grid. From the scope schematic, identify the blanking amplifier. In the Elco Model 460, this is one section of a 6J6. In this scope, connect one end of the gimmick to plate pin 2, and the other end to an insulated panel post.

In the Heath Model O-11 install the gimmick at plate pin 6 of the 12AU7. One section of this twin-triode functions as the blanking pulse amplifier, the other as part of the sweep generator.

INSPECTING A FLYBACK VISUALLY

Flyback transformers have little or no protection from dust or humidity and its corrosive effect. Over a period of time, short circuits or internal arcing can develop.

One way to determine whether a flyback is faulty is by close inspection under a strong, direct light. A shorted flyback will usually overheat and cause the wax insulating compound to melt. A small mound or clump of wax may already have formed under the transformer by the time you are called to service this set.

You may also detect the odor of smoke or burning caused by arcing at points of weak insulation or contact.

The bullet-like streaks shown in Fig. 10

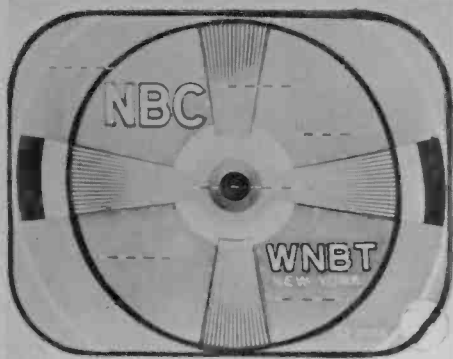

FIG. 10. Streaks in picture caused by HV arcing.



FIG. 12. Trapezoidal sweep resulting from a short across one section of vertical deflection coil.



FIG. 11. Keystoning effect of shorted horizontal yoke.



FIG. 13. Distortion due to an open capacitor at input of damper filter.

across the raster and picture, together with popping or snapping sounds are symptoms of arcing in a flyback transformer. Occasionally the expense of a flyback transformer replacement can be saved by spraying at least one coat of special high-voltage insulating compound on the windings.

COMMON SYMPTOMS

A Shorted Horizontal Yoke Winding. This will produce the keystone raster shape shown in Fig. 11. Another result will be a decrease in the high voltage. If the yoke short is sufficiently severe, the high voltage will fall entirely.

A Shorted Vertical Yoke Winding. This will cause either a complete lack of vertical sweep or the raster in Fig. 12.

Defective HV Rectifier. With no raster, you may see a small arc at the plate of the HV rectifier. Lift the lead, and if the arc assumes its normal length of about $3/8$ ", replace the

tube. Another symptom of a shorted or faulty HV rectifier tube is the thin snake-like arc observed when moving the anode lead HV connection close to the chassis.

Open Input Capacitor in Damper Filter Circuit. The narrow and distorted raster of Fig. 13 is caused by an open input capacitor in the damper filter circuit. This capacitor is C2 in Fig. 7, and C7 in Fig. 8.

Open Output Capacitor in Damper Filter Circuit. If the damper output filter capacitor (C1 in Fig. 7 and C4 in Fig. 8) opens, a narrow raster relatively free of distortion will result. Its appearance is shown in Fig. 14.

A Defective Horizontal Output Screen or Cathode Resistor. Either of these will also narrow the raster. If either or both undergo a large increase in resistance, the high voltage will be sharply reduced, and the raster will probably disappear altogether. You will always find bypass capacitors associated with the cathode and screen-grid resistors. If



FIG. 14. Loss of width due to an open capacitor at output of damper filter.

they are open or leaky, deflection troubles are bound to result.

Cathode-to-Heater Leakage. Look at Fig. 15 to see the pull in the picture and along the edge of the raster when there is heater-to-cathode leakage in the horizontal output tube.

Short in Width or Linearity Coils. One cause for deflection and high-voltage troubles frequently overlooked is a short in the width



FIG. 15. Distortion caused by horizontal output tube defect.

or linearity coils. By using a scope as described earlier, the cause of this hard-to-pin-down trouble will be quickly uncovered.

You will find these TV service pointers and special test methods both satisfying your customers and giving you that wonderful feeling of a difficult but interesting job successfully completed.

Happy Servicing!

Your Consultation Service Privilege

By J. B. Straughn

Chief, Consultation Service

You have heard it said that you can judge a product by its cost. For example, on price alone you can expect a Cadillac to have it all over a Chevrolet. But this is not always true. Take NRI. We have by far the best home-study electronic training courses available. But for many other courses actually inferior, you might be charged twice as much as for an NRI course on the same subject. How do we do it?

First, we give our students satisfaction. Students stick with NRI instead of quitting after a few payments. This means it costs NRI less to enroll a student.

Second, since we have more students going farther in our courses, our mass buying power reduces your costs. When we buy meters we don't get a hundred or so at \$10 each. Instead we may buy 10,000 at a time and at a big saving. This saving is passed on to you. There are other similar examples right down the line.

NRI watches its dollars but we don't pinch them. We have the finest Electronic Home Study Training in the world today and we spare no expense to keep it that way.

One of our big expenses is Consultation Service. Highly skilled, well paid technicians are ready at all times to answer your technical questions personally. These men are backed up by typists and stenographers who are familiar with technical terms. You can't hire such people already trained, you must train them, then pay them well, for such skills are in great demand.

Our Consultation Service brings in no income or new business. Such an expensive operation would be dropped quickly by some firms. Not by NRI! It is our Consultation Service that often makes the difference between turning out a high-quality technician and one of inferior grade.

NRI training methods must be good, because

not more than 20% of our students and graduates take advantage of their consultation privilege. But it is a comforting thought to know you can get the help of a specialist when you need it.

The NRI Consultant is a specialist! He does not grade lessons, carry mail to the post office, or type his own letters. He is too busy answering questions all day long. A Technical Consultant may dictate 5000 individual letters in a year's time. Nontechnical people often cannot understand why we must write so many letters.

We constantly get suggestions on how to lower our work load. Why don't we print more form letters, why don't we print answers on slips of paper, why don't we write our replies in longhand on the students' examination papers? Other schools do this; some even mimeograph their replies, on odd-size slips of paper, to send out in place of personal help!

One man finds an obstacle a stumbling block;
another finds it a stepping stone.

Wm. Lyon Phelps

The answer to such suggestions is that we can't run NRI's Consultation Service that way and do a good job. Our students are human beings. Each is an individual. The very letter that clears up one student's problem may confuse another student. Of course we do have a few printed letters on subjects of a specific nature, but not explanations clarifying material in our lessons or training kit manuals. When we find that a portion of a lesson text is not doing its job we rewrite the text material in the light of the information secured from our students with problems. No printed slips in answer to a student's letter for help!

How can we tell just what explanation will best suit an individual? First, from the wording of the question, and second, from past experience in handling hundreds and perhaps thousands of related or similar questions. But it is seldom that the required help is exactly the same. This accounts for our lack of form letters and form paragraphs.

For example, a student may write: "I don't understand Ohm's Law." The next student may say "I can't work Ohm's Law problems." This is followed by the student who asks "How many ohms equal a volt?" and the man who wants to know the practical uses to which Ohm's Law may be put. Then there is the practical man, who asks why he should learn Ohm's Law when all he wants is to learn how to fix TV sets.

To answer all of these questions in a printed Data sheet would take a ten or fifteen page letter. Then the student would have to wade through all of it looking for the answer to his problem. A direct answer to a specific question is appreciated by everybody. It saves time and speeds learning.

Occasionally we get a letter which might say: "I have an XYZ receiver for repair - there is a picture but no sound, and smoke is coming from a small shielded unit in the lower left-hand corner of the chassis. What should I do?" Here we use our crystal ball and reply that the plate-supply resistor is being shorted to ground by a broken-down bypass capacitor, both of which are in the i-f transformer can. Whew! It was a lucky thing that we have fixed a number of these particular receivers with the same complaint.

More difficult is the case where the question states: "Experiment 51 won't work like the book says. It's wired right and the tubes

light up -- what should I do next?"

Here we are pretty well stuck. The manual may list many things to be accomplished in this experiment. Specific information would have given us a clue to the possible causes of the trouble. In this case a letter telling how to localize the defect to a single stage and particular things to watch out for will be written. The Consultant will ask for more information if the trouble continues. He will need to know the exact nature of the complaint, that is, how the results obtained differ from those in the manual. He should know the results of all tests and observations, and the ac and dc operating voltages. He also needs to know the step number in the experiment where the trouble was first observed. With this information, he will be able to give specific suggestions if more help is required.

Requests for help in receiver repairs are more easily handled because the complaint and details regarding the picture and sound are always mentioned by the student. The Consultant can study the diagram and make specific suggestions as to the cause of the trouble, and outline the best trouble-shooting procedure.

GETTING THE MOST OUT OF YOUR CONSULTATION PRIVILEGE

Perhaps you have written us often or you may have never needed help. You may even

have felt hesitant about writing. Don't! Whenever you feel the need of help, please ask for it. We are here to aid you with any electronics problems you meet whether they are on your lessons, training kits, or service problems. You are dealing confidentially with an individual instructor who has experienced the same problems you meet. No question is viewed as being silly or not worth answering. In a class at a resident school there are questions you might hesitate to ask for fear of exposing your lack of knowledge to your fellow students. None of that here at NRI. One secret of our Consultants' success is their ability to put themselves in your place and to remember what they didn't know when their training equaled yours. They must be able to do this, for otherwise they could not know where your thinking has gone astray and could not put you back on the right path.

This is why it's so important when writing to give us full details. If there is something in a lesson you can't completely understand, be sure to tell us what you do think about it. This will enable us to diagnose your case and give you a hand-tailored reply that will best serve your individual needs.

If you have a suitable Consultation Blank, use it. If you use ordinary paper, your letter will reach the Consultation Section only after it has gone through our Student Service Section, where nontechnical problems are handled. Letters written on Consultation Blanks are routed directly to the Instruction Department.

AIR MAIL

If you don't want an air mail reply NRI pays the postage; but, if you enclose an air mail stamp your reply will go to you by air mail. On the East Coast this is generally a waste of money, as overnight mail service is the general rule, even if an ordinary stamp is used. If you are in the Service and are stationed overseas, air mail is far quicker. If you request a TV diagram, an extra air mail stamp will usually take care of the postage. West Coast students will find air mail a real time saver but not a necessity except where rush service jobs are involved.

PHONE CALLS

Because we want to give the best service possible, we would rather get a letter than a phone call. With a letter we can give a considered answer and perhaps more information than by phone. However, if you do phone for help, we will do our best to aid you; but remember, we cannot accept collect calls. The phone number at the Institute is Emer-

son 2-9700. When our Switchboard Operator answers, tell her you are an NRI student or graduate and that you want help with a technical problem. She will switch your call to the Instruction Department. Tell the clerk answering the phone the general nature of your problem, and she will route your call to a Consultant who is free at that time.

Do not ask for an individual even though your call is the result of a letter from him. He may be out or otherwise not available and your time would be slipping away. Any of our Consultants can aid you.

If your call is nontechnical -- deals with lesson texts missing, an overdue examination, your rate of study or payments, our Switchboard Operator will need your name and student number so she can refer you to the Student Service Correspondent handling your account.

VISITS TO NRI

If you are ever in Washington please come and see us -- friends with you will also be welcomed. You will be given a conducted tour of our entire building by a member of the Instruction Staff and will see for yourself what makes NRI the leader in its field. You'll see where your records are kept, the way we pack your demonstration kits, our Printing Section, how your lessons are sorted and graded, our laboratories and the Consultants in the Instruction Department hard at work answering students' and graduates' requests for help. If you want to chat with any member of our staff, you'll find him delighted to meet you and to answer any questions you have on your mind. Whether we meet you over the phone, by a letter, or at our Reception Desk, remember that to every employee at NRI you are a very important person, and that our aim is to see you successful in your chosen field.

TO EACH, HIS HOUR

Lord -- give me the patience to fully appreciate the other man's adventures without interrupting him with mine.

Let me realize that the things which happen to my fellow man place him, however briefly, in the spotlight among his brothers, and he should be allowed to savor the telling to the fullest.

Grant that I may give to each man, HIS HOUR.

--Martin Buxbaum --

Dressing up the Model W VTVM

By Carl D. Sharpless
NRI Consultant

Although the Model W VTVM is complete and professional looking as is, there have been requests from owners for instructions on making certain types of modifications to "dress up" the tester. The first step, and the biggest improvement, is a case for the tester. These are available from the NRI Supply Division. They list for \$4. Many new owners hesitate to buy a case because they believe that the tester has to be constantly calibrated. This would mean constantly removing the tester from the case. However, this is not true. Once the tester has been completely and correctly calibrated, it does not require recalibration unless the 1.5-volt cell in the tester becomes weak. This takes between 4 and 6 months, depending upon the amount of use given the tester. The Zero Set and the Ohms Set control may require adjustment each time the tester is first turned on. However, these controls are located on the front panel.

Two of the most common requests we receive are for instructions for making the tester's leads detachable and for installing an indicating light. The instructions for making these modifications are given here.

DETACHABLE LEADS

There was a purpose in designing the Model W VTVM with permanent leads. Detachable leads can be easily misplaced and thus lost. Permanent leads are always available when needed. However, if you desire, only a slight modification of the tester is required to make the present leads detachable. Mr. Terry Brunt, Cobble Hill, B. C., Canada, suggested the use of an Amphenol Connector (Type 75-MC1F with type 75MC1M receptacle - not sold by NRI. Purchase through wholesaler). We have found that this type of connector is easy to install and works satisfactorily.

The first step in making the modification is to disconnect the tester's leads from the terminals on the Function Switch. Remove the leads and the rubber grommet from the hole in the panel and lay them aside. The hole is large enough to mount the receptacle unit as is. However, it must be insulated from the VTVM chassis. Fiber washers (3/8") can be used for this purpose. The washers are to be mounted on the front and back of the panel. One of the washers should have a raised shoulder. This washer can be mounted either

on the back or on the front. The hole has to be enlarged so that the raised shoulder will mount in it. The hole can be reamed to proper size.

After the hole has been modified for the washers, the receptacle can be mounted. Install the washers and then the receptacle unit. The receptacle is held in place with a hex nut. Make sure the nut is tight, as there will be strain placed on the receptacle unit by the constant insertion and removal of the tester leads. Be careful not to damage the grooves on the front end of the unit.

Now you are ready to connect the receptacle to the Function Switch. You will use part of the probe lead. Cut off a 4-inch portion from the end of the probe lead. Next remove a 1-inch portion of the rubber insulation from the cut end. Do not remove the shielded braid. Slit the braid lengthwise and twist it together as on the other end of the lead. Now remove about 1/4-inch of the plastic covering from the end of the lead. Insert the lead into the receptacle unit and solder the connection from the front side. Lay the tester on its back so the solder will run down into the receptacle unit. The shield can be soldered to the hex nut on the receptacle unit itself. The connection to the hex nut is preferable. However, if it is aluminum this cannot be done.

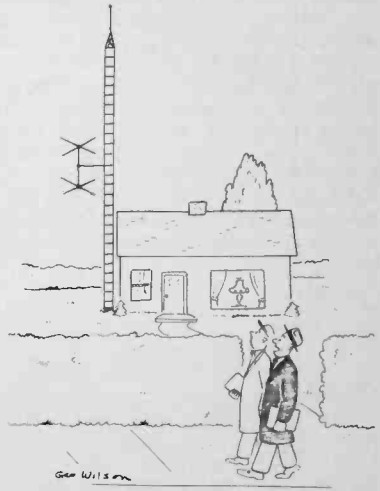

It is in mourning. The finance company took his set.

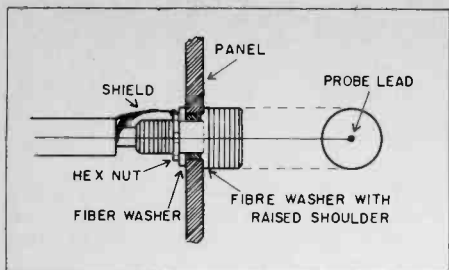

FIG. 1. Receptacle unit mounting.

Now reconnect the other end of the four-inch probe lead and shield back to the appropriate terminals on the Function Switch. Refer to Fig. 1 for a cross-sectional view of the complete receptacle assembly.

To connect the leads to the connector unit, we must first prepare the leads. Remove about 1-1/4 inches of the rubber insulation from the probe lead. Again do not remove the shield. Prepare the shield as before. Next, remove about 1/4 inch of the plastic covering from the lead. If you haven't already done so, disconnect the spring from the connector by loosening the set screw in the connector unit. Now place the ground lead beside the probe lead in such a manner that the bare portion of the ground lead is overlapped on the shield of the probe lead. The ends of the ground lead and the shield should be even.

Place the spring over the leads. This is done by twisting the spring or leads while applying pressure. The spring has to be placed far enough over the leads so that approximately one inch of the probe lead sticks out. The shield and the bare portion of the ground lead should also stick out. Twist the shield and the ground lead together and bend them back over the spring. Solder these leads to the first turn on the spring. Use as little solder as possible, but assure a firm electrical and physical connection. Cut off the excess as close to the soldered connection as possible. Be careful when making the soldered connection that you do not melt the plastic covering over the

probe lead. Fig. 2 shows a cross-sectional view of the connections to the spring.

Now mount the spring and leads to the connector. To do this, insert the leads into the connector and solder the probe lead to the unit. Place the connector so that the solder will run down into the unit and on the probe lead. Next tighten the set screw.

Check the connections for opens or shorts by using the ohmmeter section of the VTVM. Attach the leads to the tester. With the Function Switch on Ohms and the Range Switch in the RX1M position, apply pressure to the spring and note the meter pointer. It should not deflect. Now turn the Range Switch to the RX1 setting and clip the leads together. A reading close to zero should result. Again apply pressure to the spring and note the meter pointer. A movement of the pointer indicates a poor connection.

You are not limited to the type of connector listed above. However, regardless of the type used, the ground connections must be insulated from the VTVM chassis. Also, the present probe lead and cable should be used for maximum accuracy.

INDICATING LIGHT

There is no actual need for an indicating light on the VTVM. A glance at the Function Switch setting will reveal if the tester is turned on. However, an indicating light does give a 'dressed-up' appearance to the tester. The light can be mounted either in the meter or on the front panel. The panel light is more noticeable or revealing and easier to mount, thus more practical. However, we will describe both types of mounting.

Light in Meter. The mounting of the indicating light in the meter has to be done very carefully. The meter is a delicate mechanism and can be easily damaged, and is rather expensive to replace. The mounting of the light is not too difficult. However, if you do not think that you can mount the light without damaging the meter, I do not suggest that you attempt it.

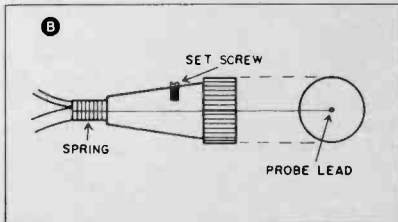
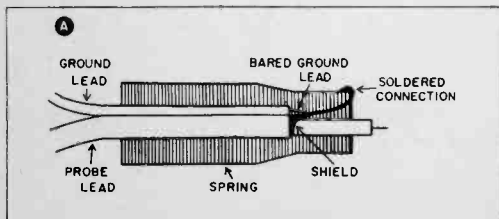

FIG. 2. (A) Spring connections; (B) completed connector assembly.

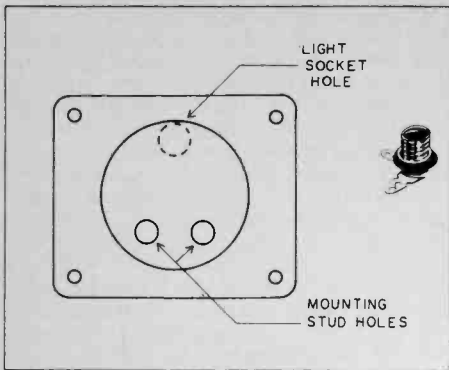

FIG. 3. Back cover of meter showing locations of socket hole.

To allow access to the dial, the plastic cover on the meter has to be removed. To remove the front cover, hold the meter in one hand by the portion that contains the magnet and the terminals. With the meter pressed against your body or some other object to steady it, pull the cover away from the meter unit. Apply pressure at only one corner. The cover should come free. Do not pry under the cover with a screwdriver, as there is a good chance of cracking the cover. Once the cover has been removed, handle the meter with extreme care so that the pointer and meter movement are not damaged. The back cover is removed by unscrewing the nuts on the studs that hold the terminal lugs in place. Remove the terminal lugs and all washers from the studs. Holding the meter by the sides, push the studs forward. Once they break loose, the cover can be easily removed.

The light socket is to be mounted in the circular protrusion of the back cover. A standard type pilot-light socket can be used. Therefore use a $3/8$ " drill to make a hole, and ream it to the proper size. Do not apply pressure to the drill while cutting the hole, as the cover can be easily cracked. Both the bulb and the socket must be kept from contact with the meter mechanism. Therefore the hole has to be made as near the top of the cover as possible. Refer to Fig. 3. After the hole has been drilled it is to be reamed until a $3/8$ -inch rubber grommet can be mounted. You probably won't be able to completely mount the grommet, because of the thickness of the cover. However, after the grommet has been placed in the hole, insert the lamp socket by slowly twisting it back and forth. This will force the grommet into position. The terminals of the socket should be positioned so the terminals are towards the bottom of the cover. Make sure all filings are removed from the cover and insert the

6.3-volt pilot light. Now we are ready to drill the hole in the dial plate.

Remove the dial plate from the meter unit before you drill the hole. If not, the filings will fall into the meter mechanism and ruin it. To remove the dial plate, remove the two small screws holding it in place. Be careful that you do not lose the screws, as replacements would be difficult to obtain.

There are two different types of dial plates used on these meters. One has a complete open section around the bottom pointer mechanism. In this type, the dial plate can be slid upward under the pointer until free.

The other type has a rectangular cut-out around the pointer mechanism. If you have this type of meter, slide the dial plate down until it is free of the pointer base, and then slide it up until it is free of the pointer. You may have to apply pressure to do this, but it will spring back into place. Do not use enough force to permanently bend the pointer.

When the dial plate is removed, put the meter in a safe place away from any metal filings which could cling to the magnet, thus ruining the meter.

The light hole in the dial plate is to be made by a No. 42 drill. The hole should be made midway between the red ac scale and the letters "NRI." To center the hole, place it in line with the "R" of NRI. Be sure to score the hole before drilling. This will prevent slipping of the drill, which would damage the dial face. Clear off any burrs with a sharp knife or oversize drill and wipe both sides of the dial plate to remove any loose metal particles.

After the hole has been drilled, use clear Scotch tape to attach a piece of red cellophane on the back of the dial plate over the hole. A piece of red cellophane strip from a cigarette pack can be used. Several strips may be necessary to cover the hole. These can be placed in a cross pattern, as illustrated in Fig. 4. The light rays from the pilot lamp shining through the cellophane strip will produce a very effective red indicating light. Replace the dial plate on the meter unit by sliding it under the pointer and into place. Again, be careful in doing this so the pointer is not bent.

The cover can now be replaced. The back cover should be replaced first. The terminal lugs should be positioned on the studs so that they point downward. Do not tighten the nuts on the studs too much as the cover can be cracked. Next, replace the front cover. Note there is a nipple on the plastic screw in the

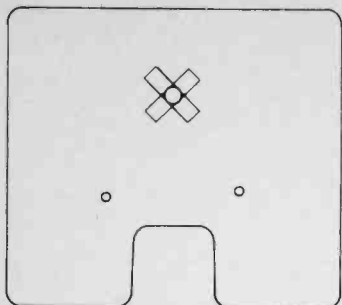

FIG. 4. Back side of dial plate showing recommended position of cellophane strips.

cover. The cover is to be replaced with this nipple inserted in the hole in the mechanical zero adjuster of the dial pointer. To do this, the zero adjust may have to be positioned by hand. The pointer can be returned to zero after replacing the cover by adjusting the plastic screw.

The indicating light can now be wired into the circuit. Twist together two 10-inch pieces of hookup wire. Connect one end of these wires to the pilot light socket. Run the leads down and through the hole on the chassis in which the meter leads are inserted. Then run the wires along the chassis to the 7-pin tube socket. Connect one lead to pin 3 and the other to pin 4. This connects the pilot light across the 6X4 tube filaments. Don't forget to reconnect the meter leads.

Panel Light. An indicator light can be mounted on the front panel with little or no difficulty. The light must be mounted between the Zero Set and the Ohms Set controls. This is the only place where room is available. For a professional looking job, the light should be mounted midway between the controls and positioned so that the top of the light is in line with the center of the control knobs. In other words, do not place the light directly in line with the controls but lower it slightly, as shown in Fig. 5.

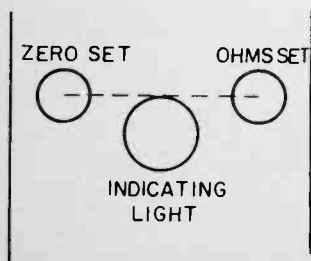

FIG. 5. Positioning of panel indicating light.

The series 610 candelabra screw-type indicator light-socket shell is recommended. This is an open type with a faced jewel and lug terminals, as illustrated in Fig. 6. It can be purchased from most Radio-TV wholesalers. The socket shell is available with jewel colors of red, green, or amber. This unit requires a 7/16-inch mounting hole. This is an off-size, but you can use a 3/8-inch drill to make the hole, and then ream it to proper size.

Since the lug terminals are insulated from the socket shell, and thus from the chassis, no grommet or washer is required in the hole. The resistors connected between the Zero Set control and the 3-lug terminal strip will have to be disconnected from the terminal strip to allow free access to the section of the panel where the socket is to be mounted.

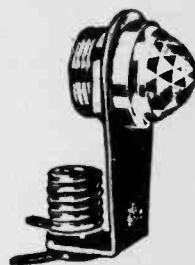

FIG. 6. Candelabra-type socket shell.

Position the socket shell so that the socket terminals are towards the bottom edge of the panel. The light is to be connected across the filaments of the 6X4 tube. To do this, loosely twist together two 10-inch pieces of hookup wire. Connect the wires to the terminals on the light socket, then run them down to the chassis, and then along the chassis to the 6X4 tube (7-pin) socket. Connect one lead to pin 3 and the other to pin 4.

Reconnect the resistors to the terminal strip after completing the modification, but be sure to insert the pilot lamp into the socket before replacing the resistors as this will be difficult to do afterwards. Use a screw-type 6.3-volt lamp.

You are not limited to the type of indicating unit mentioned above. However, you should use a jewel-type unit. If the terminals on the shell are not insulated from the shell, then a fiber washer or grommet has to be used to insulate the unit from the chassis, because the VTVM circuit is constructed so that it is above chassis ground.

Nothing is ever all wrong. Even a clock that's stopped is right twice a day.

NRI ALUMNI NEWS

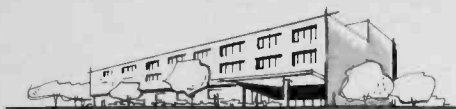

| | |
|--------------------|-----------------|
| Jules Cohen | President |
| F. Earl Oliver | Vice President |
| John Babcock | Vice President |
| J. Arthur Ragsdale | Vice President |
| Howard Smith | Vice President |
| Theodore E. Rose | Executive Sect. |

Chapter Chatter

DETROIT CHAPTER reports that the members most recently admitted are: Charles Cope, Oscar Smith, and Chester Wodzinski. It is a pleasure to number you among the membership, gentlemen.

Not to be outdone by the other local Chapters, the Detroit Chapter is conducting a series of transistor projects by different members of the Chapter. At a recent meeting Asa Belton, James Kelley, and Leo Blevins gave very interesting demonstrations on different transistor circuits.

Honorary member Charlie Mills was elected permanent chairman of the Nominating Committee for elections.

The Chapter has been planning a demonstration by RCA on color Television.

FLINT (SAGINAW VALLEY) CHAPTER held a lively session on B and K Models 107 and 1075. Jerry Acuff demonstrated the two instruments. There ensued a heated discussion on the part of Wayne Todd, Arthur Clapp, William Jones, Harm Gillean, and Clyde Morrissett. The give-and-take became so spirited that Andrew Jobaggy, in whose shop the meeting was held, suggested that the

subject be postponed until the next meeting when there would be more members with other test instruments present.

There were more members at the next meeting -- in fact, twice as many. This is the result of the popularity of the series of lectures being conducted by Professor DeJenko. These lectures are devoted to the methods and problems encountered in today's Radio-TV servicing. All members of the Chapter should take advantage of the opportunity to attend these excellent lectures.

LOS ANGELES CHAPTER, like most of the other local Chapters, has been giving a good deal of attention to transistors. Jessie Davis gave talks on this subject at two separate meetings. At the first one he talked about transistors in general -- the different uses of each type of transistor, the care that should be used in employing them, etc. At the subsequent meeting he accompanied his talks with blackboard drawings. This was a particularly fine talk. He discussed the subject like an expert and held all the members spellbound.

The Chapter reports its officers for 1961 as follows: Eugene DeCaussin, Chairman; William Edwards, Vice Chairman; Fred Tevis, Treasurer; and Earle Allen, Jr., Secretary. Our congratulations to these officers!

Chairman DeCaussin raised the question as to whether the members are interested in building a citizen's band transceiver or a ham radio -- each member to build his own set -- or whether all the members should participate in building the Chapter's own ham station.

The latest member admitted to the Chapter is John L. Knapp. Welcome to the Chapter, John!

MILWAUKEE CHAPTER has been concentrating on transistor Radio receivers. Assisted by John Edgerton and James Lasky, Slavko Petrich gave an excellent blackboard



Flint Chapter members Andrew Jobaggy, Wayne Todd, Charles Rupp, Clyde Morrissett, Roland DeSisto, Harm Gillean, Arthur Clapp, and Wm. Jones earnestly listening to Prof. DeJenko (with pointer).

talk on servicing transistor Radios. He stressed the danger of indiscriminately cutting out parts for test purposes, and compared the method used in servicing transistor and vacuum tube circuits.

The servicing of transistor and hybrid auto receivers was scheduled for the next meeting.

MINNEAPOLIS-ST. PAUL (TWIN CITIES) CHAPTER former Chairman John Berka delivered a talk on common faults in the 1959 and 1960 models of the Motorola TV receivers. Members always welcome the opportunity to listen to John, as he is an expert and thoroughly experienced Radio-TV serviceman.

Harold Lindquist agreed to deliver a talk based on NRI Consultant Dale Stafford's article on Ohm's Law appearing in the December-January issue of the NRI News. Walter Berbee was scheduled to give a signal-tracing demonstration with his scope at the January meetings. The members are always glad to hear from Walter, too, as he is also a skillful and experienced full-time Radio-TV serviceman.

Another member, who works with servo-mechanisms, has consented to give a talk on them at the March meeting. This will be something new for most of the members.

The members were very grateful to Mrs. John Berka for the wonderful luncheon, particularly the delicious ham salad sandwiches and the cookies, which she furnished the Chapter for refreshments at the December meeting.

Joseph Kranitz, St. Paul, was recently admitted to the Chapter. A warm welcome to you, Joe!

NEW YORK CITY CHAPTER celebrated its



NRIAA Executive Secretary Ted Rose presenting plaque to Frank Zimmer on behalf of NYC Chapter members at 25th Anniversary Celebration. At left: Mrs. Jim Eaddy, wife of the Chapter's 2nd Vice Chairman, and, back to camera, Bert Wappler, a much-respected former chairman of the Chapter.

25th Anniversary with a dinner and party at its usual meeting hall. It was a catered affair with excellent food and drinks. Music was supplied by Frank Zimmer's tape recorder and Chairman Dave Sitzer's record player.

There were 54 members present, about half of whom brought their wives or other guests. Each member received a gift of jewelry for his lady companion and a set of books for himself. Among the guests were Mr. and Mrs. Chas. Fehn and Mr. and Mrs. Chas. Wells of the Philadelphia-Camden Chapter, J. B. Straughn of the NRI Instruction Staff, and Ted Rose, Executive Secretary of the NRIAA.

Frank Zimmer was awarded a plaque for his 25 years of faithful service as a member of the Chapter. Ted Rose made the presentation for the Chapter.

The members elected the following officers for 1961: David Spitzer, Chairman; Tom Hull, Exec. Chairman; Frank Zimmer, 1st Vice Chairman; James Eaddy, 2nd Vice Chairman; Frank Catalano, Treasurer; and Samuel Jacobs, Jr., Secretary. Our congratulations to these officers!

PHILADELPHIA-CAMDEN CHAPTER members were enthusiastic about a talk given at one of their meetings by Mr. Dave Linz, representative of Globe Units, Citizen's Band Equipment. Mr. Linz has a thorough knowledge of this subject. He spoke for two hours, and the members present would have liked to have him continue for another hour. He gave the members a good insight of citizen's band equipment, antennas, and proper installation methods. He also gave the Chapter an application for an FCC license for the citizen's band and explained how to make it out. Mr. Linz was himself impressed with

the interest and sincerity of the sixty members assembled at this meeting to hear him.

It was announced in the December-January issue of the NRI News that the Philadelphia branch of the General Electric Company had arranged for another "National Radio Institute Alumni Night" to be held on December 12. As everyone knows, of course, the bad snowstorm we had at that time seriously disrupted practically all activities, including this event which had to be postponed. At the time this issue of the magazine went to press no report had been received on any new date that might have been set for this party.

The newest members of the Chapter to be reported are: Joseph Giba, R. J. Hollenbach, and Ralph Whitehead. Congratulations to these new members!



Officers of the Pittsburgh Chapter for 1961. Seated, l to r: Jack Fox, Charles Kelley, Howard Tate. Standing: Wm. Sames, Edgar Lowther, Wm. Lundy, James Wheeler.

PITTSBURGH CHAPTER was pleased to receive a visit from Jules Cohen, Secretary of the Philadelphia-Camden Chapter. Jules made a brief talk at the meeting and in his talk he stressed the importance of making every effort to defeat the proposed bill to license Radio-TV servicemen in Pennsylvania. At this same meeting Howard Tate delivered a fine talk on the use of the oscilloscope.

The members held their usual Christmas party at the final meeting of the year. First, however, the officers for 1961 were elected. They are Howard Tate, Chairman; Charles Kelley, Vice-Chairman; James Wheeler, Secretary; Jack Fox, Treasurer; William Lundy, William Sames, and Edgar Lowther, Executive Committee. NRIAA Executive Secretary Ted Rose, who was present on his annual visit to the Chapter, administered the oath of office to the new officers. The rest of the evening was devoted to socializing and to demolishing the excellent buffet supper provided by the Chapter for the occasion.

Recently admitted to membership in the Chapter were: A. J. Ciarrocca, Corraopolis, and G. F. Genelle, Pittsburgh. A warm welcome to these newest members!

SAN FRANCISCO CHAPTER'S former chairman, Art Ragsdale, discussed a TV set he had repaired. There was no high voltage or picture, but the sound was okay. There were 25 volts where there should have been 200 volts on the horizontal tube. The grid voltage was positive where it should have been negative. This was due to two shorted capacitors and one open capacitor. The oscillator could

not operate properly because of these defects. Program Chairman Anderson Royal demonstrated on the blackboard what was wrong with a "tough dog" radio. The trouble was located in the amplifier circuit as an open rf bypass capacitor, causing low plate voltage. Both of these discussions were interesting and enjoyed by the members.

At the next meeting Art Ragsdale spoke on vertical output trouble in a TV receiver. The difficulty was due to an open in the vertical linearity control. After the control was changed, the picture became normal again.

The Chapter elected its officers for 1961 as follows: Edward Persau, Chairman; Reginald Selby, Vice-Chairman; J. Arthur Ragsdale, Secretary; Charles Kilgore, Treasurer; and George Law and Peter Salvotti, Finance Committee. Our best wishes to these successful candidates.

Recently admitted to membership in the Chapter were Edward Narva and Eugene Nielsen. Congratulations to these new members!

All members of the Chapter, please note: meetings will no longer be held at the Bay View Federal Savings and Loan Association. The new meeting place will be announced in a forthcoming issue of the NRI News.

SOUTHEASTERN MASSACHUSETTS CHAPTER'S Manuel Sousa delivered an interesting and instructive talk on signal-seeking tuners. He went through the tuner from start to finish, working very slowly, and explained each part and its function.

At the next meeting the Chapter's newest member, Edward Bassett, brought with him his NRI TV set with which he was having trouble. John Alves, using his scope, traced the trouble in part to the horizontal sweep circuit, but because of lack of time was unable to pursue the culprit further. The schematic of the set was passed around and every member had a crack at diagnosing the trouble.

Under the chairmanship of Mike Lesiak, the nominating committee selected and submitted its recommendations for the officers to serve the Chapter for 1961. The report on these elections could not reach National Headquarters in time for this issue of the News. The report on the successful candidates will be included in the next issue.

Members chipped in to get John Alves a Christmas gift as a token of their appreciation for providing the Chapter with such a fine meeting place.



Part of the group of members who attended the Springfield Chapter's Shop Meeting at Walter Ciszewski's shop.

Congratulations to the latest members admitted to the Chapter, Daniel Defjesus and Edward Bassett!

SPRINGFIELD CHAPTER enjoyed a particularly interesting and rewarding Shop Meeting in Walter Ciszewski's shop. Members brought in three TV receivers, one transistor set, and two Radios. Members found that locating and correcting the defects in these was indeed intriguing. Those who attend the Chapter's Shop Meetings get a great deal of practical help from them.

At the following regular meeting Mr. Leonard Gage and Mr. Harold Brennan of the New England Tel. and Tel. exhibited a 30-minute sound film entitled: "Thanks for Listening." Mr. Gage volunteered the information that a new film "Seconds for Survival," has been released. This film deals with emergency action to be taken by all in case of an actual attack by an enemy on U. S. soil. Requests for the film should be made six months in advance, to: New England Tel. and Tel., attention: Mr. Leonard Gage, Worthington St., Springfield, Mass.

The members present at this meeting took up a collection, the proceeds of which were contributed to the "Toy for Joy" Fund.

Directory of Local Chapters

Local chapters of the NRI Alumni Association cordially welcome visits from all NRI students and graduates as guests or prospective members. For more information contact the Chairman of the chapter you would like to visit or consider joining.

CHICAGO CHAPTER meets 8:00 P.M., 2nd and 4th Wednesday of each month, 666 Lake Shore Dr., West Entrance, 33rd Floor, Chicago. Chairman: Edwin Wick, 4928 W. Drummond Pl., Chicago, Ill.

DETROIT CHAPTER meets 8:00 P.M., 2nd and 4th Friday of each month, St. Andrews Hall, 431 E. Congress St., Detroit. Chairman: James Kelley,

1140 Livernois, Detroit, Mich.

FLINT (SAGINAW VALLEY) CHAPTER meets 8:00 P.M., 2nd Thursday of each month, St. Agnes School Annex, 518 W. Pierson Rd., Flint. Chairman: George Rashead, 338 E. Marengo Ave., Flint, Mich.

HAGERSTOWN (CUMBERLAND VALLEY) CHAPTER meets 7:30 P.M., 2nd Thursday of each month, "The Nook" Restaurant (rear), Hagerstown, Md. Chairman: J. Howard Sheeler, 300 Walnut St., Shippensburg, Pa.

LOS ANGELES CHAPTER meets 8:00 P.M., 2nd and last Saturday of each month, 4415 Santa Monica Blvd., L. A. Chairman: Eugene De Causin, 5870 Franklin Ave., Apt. 203, Hollywood, Calif.

MILWAUKEE CHAPTER meets 8:00 P.M., 3rd Monday of each month, Radio-TV Store and Shop of S. J. Petrich, 5901 W. Vliet St., Milwaukee. Chairman: Philip Rinke, RFD 3, Box 356, Pewaukee, Wis.

MINNEAPOLIS-ST. PAUL (TWIN CITIES) CHAPTER meets 8:00 P.M., 2nd Thursday of each month, Walt Berbee's Radio-TV Shop, 915 St. Clair St., St. Paul. Chairman: Kermit Olson, 5705 36th Ave., S., Minneapolis, Minn.

NEW ORLEANS CHAPTER meets 8:00 P.M., 2nd Tuesday of each month, home of Louis Grossman, 2229 Napoleon Ave., New Orleans. Chairman: Herman Blackford, 5301 Tchoupitoulas St., New Orleans, La.

NEW YORK CITY CHAPTER meets 8:30 P.M., 1st and 3rd Thursday of each month, St. Marks Community Center, 12 St. Marks Pl., New York City. Chairman: David Sitzer, 2052 81st St., Brooklyn, N. Y.

PHILADELPHIA-CAMDEN CHAPTER meets 8:00 P.M., 2nd and 4th Monday of each month, Knights of Columbus Hall, Tulip and Tyson Sts., Philadelphia. Chairman: Herbert Emrich, 2826 Garden Lane, Cornwell Heights, Pa.

PITTSBURGH CHAPTER meets 8:00 P.M., 1st Thursday of each month, 436 Forbes St., Pittsburgh. Chairman: Howard Tate, 615 Caryl Dr., Pittsburgh, Pa.

SAN FRANCISCO CHAPTER meets 8:00 P.M., 1st Wednesday of each month, new meeting place to be announced later. Chairman: E. J. Persau, 1526 Wayland St., San Francisco, Calif.

SOUTHEASTERN MASSACHUSETTS CHAPTER meets 8:00 P.M., last Wednesday of each month, home of John Alves, 57 Allen Blvd., Swansea, Mass. Chairman: Arthur Hubert, 1566 Pleasant St., Fall River, Mass.

SPRINGFIELD (MASS.) CHAPTER meets 7:00 P.M., 1st Friday of each month, U. S. Army Hdqts. Building, 50 East St., Springfield, and on Saturday following 3rd Friday of each month at a member's shop. Chairman: Norman Charest, 43 Granville St., Springfield, Mass.

J.E. SMITH CELEBRATES HIS 80TH BIRTHDAY

Picture on this page look familiar? We're sure it does -- to students, graduates, and millions of other people the world over.

For nearly 50 years, this photo of our beloved founder J. E. Smith (now serving as Chairman of the Board) appeared in hundreds of thousands of magazine ads. We've often heard "J.E." referred to as, "the 3rd Smith brother."

In the month of February, Mr. Smith celebrates his 80th birthday. It's indeed a tribute to any man to reach the age of 80. But to have taken an active and often strenuous part in what has become the fastest growing major industry -- makes it more than just a birthday for J.E. Each birthday has been a milestone -- a page in history -- as fact-filled as that of Radio itself.

From the days of "wireless," station KDKA's first broadcast in 1920, crystal sets -- to computers, radar, satellites shadowing the earth, and TV as common as "indoor plumbing," Mr. Smith is one of few men who can vividly recall every major achievement made in the field of Radio-TV-Electronics.

There are many fond memories here -- and a promise of even more remarkable things to come in the ever-growing, multibillion dollar industry. But for Mr. Smith, these memories are secondary.

Want to know where his thoughts are -- for the present, past, and future? There's nothing with more meaning to him than the strong sense of accomplishment and pride he has gained in helping over ONE HALF MILLION men toward a more productive life -- a better standard of living for themselves and their loved ones. Nearly a half century work-

ing shoulder to shoulder with YOU -- and the thousands who have gone before building a thriving industry -- an industry now essential to the well-being of every man, woman, and child.

The folks here at NRI want to do something very special for J.E. on this occasion. We need your help to present him with the best possible birthday gift we can think of.

It's not greeting cards, shirts, neckties, or candy. Instead, his lifelong dedication and ambitions make it clear what he'd like most as a gift. It is an OPPORTUNITY -- the OPPORTUNITY to train even more men for successful careers in Radio-TV-Electronics or Appliance Servicing.

You can do your part -- easily -- quickly -- to make it a truly Happy Birthday for Mr. Smith. Just give us the name of one man whom you feel would make a good NRI student. We'll send him an NRI catalog -- won't use your name. But be sure to give us your name and student number so you'll get full credit for your friend's enrollment.

We know we can count on the full cooperation of every NRI man in making this "special gift" an outstanding success.

Just clip the coupon at the bottom of this page and send it along to us -- or use a separate sheet of paper. We'd like to have all names in by March 15th. Won't you please send us one friend's name now -- before it slips your mind?

Our heartfelt thanks to all of you for your help!

The Editors



The Editors, NRI News
National Radio Institute
3839 Wisconsin Ave.
Washington 16, D. C.

Dear Editors:

Here's my contribution toward Mr. Smith's "special" gift. This man would make a good NRI student. Send him the NRI catalog, which describes the course I have checked:

Radio-Television Servicing _____
Radio-Television Communications _____
Servicing Electrical Appliances _____
Electronics: Principles, Practices, _____
Maintenance (Industrial Electronics) _____

Friend's Name _____

Address _____

City _____ Zone _____

State _____ Approx. Age _____

His Education -- _____
if you know _____

Your Name _____

Student Number _____

City _____ Zone _____

State _____

1b2

NRI NEWS
Washington, D. C.
3939 Wisconsin Ave.

Mr. George A. Storms, Jr. E237-A622-G
410 Smith St.
York, Penna.

4A

Second-class
postage paid
at Washington, D. C.